

9-40V
Continuous Input

0-40V
Output

20A
Current

Non-Isolated

Eighth-brick
DC-DC Converter

The NiQor® eighth-brick DC-DC converter is a non-isolated buck-boost regulator, which employs synchronous rectification to achieve extremely high conversion efficiency. The High Input Voltage NiQor Brick family of converters can be used in traditional DPA (distributed power architecture) systems or provide a regulated output voltage from a battery source or other variable voltage source. The NiQor Brick family can be configured to Buck the input voltage down to a lower voltage or Boost the input voltage up to a higher voltage using a single external resistor. The module is RoHS 6/6 compliant (see last page).

NiQor®

Non-Isolated



NiQor Eighth-brick module

Operational Features

- High efficiency, 96% at full rated load current
- Delivers up to 20A of output current
- Input Voltage Range: 9-40Vdc
- Output Voltage Range: 0-40V (negative output is possible)
- Extensive on-board input and output filtering
- No minimum load requirement means no preload resistors required
- Adjustable current limit with current monitor

Protection Features

- Input under-voltage lockout protects the converter at low input voltage conditions
- Over-current shutdown protects converter from excessive load current or short circuits
- Input/output over-voltage protection protects load and regulator from damaging voltages
- Thermal shutdown protects converter from abnormal environmental conditions

Mechanical Features

- Industry standard eighth-brick pin-out configuration
- Sizes: .99" x 2.39" (25 x 60.6 mm)
- Total height only 0.500" (12.7 mm)
- Total weight: 2.2 oz (61 g)

Safety Features

- UL 60950-1
- EN 60950-1
- CAN/CSA C22.2 No. 60950-1

Control Features

- On/Off control
- Output voltage trim permits custom voltages
- Remote Sense
- Settable current limit - "C" option only
- Output voltage trim range of 0V - 40V

Contents

	Page No.
Standard Mechanical Diagram	2
Flanged Mechanical Diagram	3
Technical Specification	4
Standards & Qualifications	9
Application Notes	10
Ordering Information	13

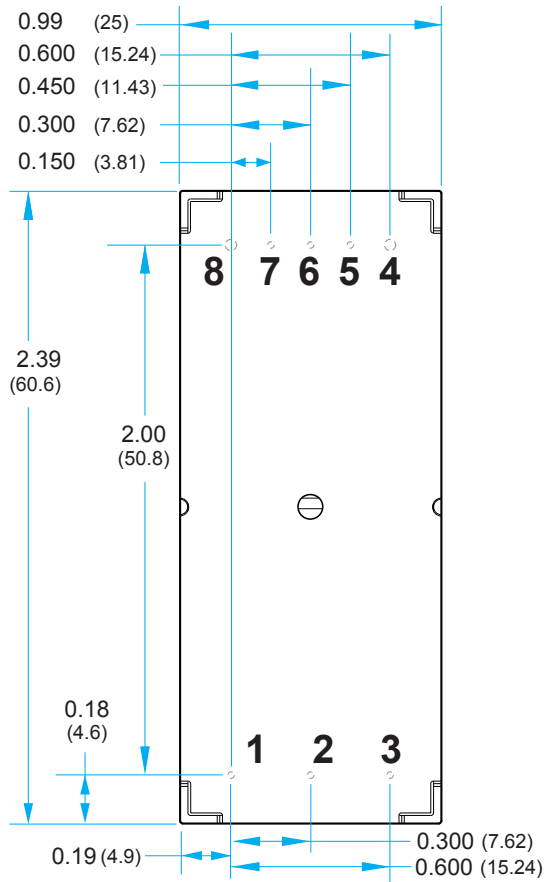

Top View

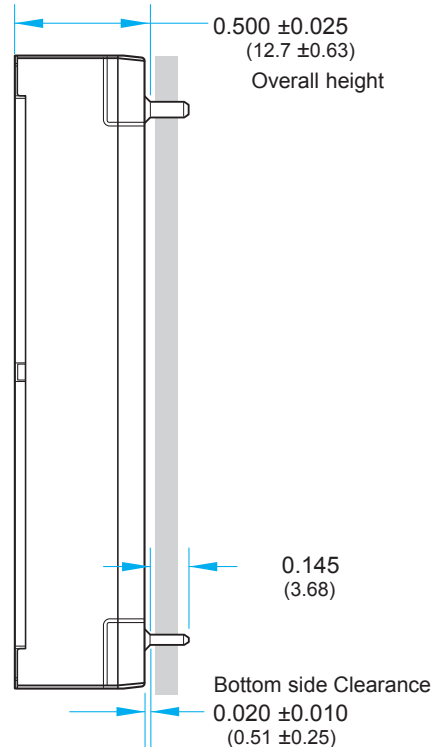

Side View

NOTES

- 1) BASEPLATE FLATNESS TOLERANCE IS 0.004" (.10mm) TIR FOR SURFACE
- 2) PINS 1-3, 5-7 ARE 0.040" (1.02mm) DIA. WITH 0.080" (2.03mm) DIA. STANDOFF SHOULDERS
- 3) PINS 4 AND 8 ARE 0.062" (1.57mm) DIA. WITH 0.100" (2.54mm) DIA. STANDOFF SHOULDERS
- 4) ALL PINS: MATERIAL: COPPER ALLOY
FINISH: MATTE TIN OVER NICKEL PLATE
- 5) UNDIMENSIONED COMPONENTS ARE SHOWN FOR VISUAL REFERENCE ONLY
- 6) ALL DIMENSIONS IN INCHES(mm)
TOLERANCES: X.XXIN +/-0.02 (X.Xmm +/-0.5mm)
X.XXXIN +/-0.010 (X.XXmm +/-0.25mm)
- 7) WEIGHT: 2.2oz (61g) TYPICAL
- 8) WORKMANSHIP: MEETS OR EXCEEDS IPC-A-610 CLASS II

PIN DESIGNATIONS

Pin	Label	Function
1	+VIN	Positive input
2	ON/OFF	TTL input to turn converter on and off, referenced to Vin(-), with internal pull up
3	-VIN	Negative input voltage, internal short to Pin 4
4	-Vout	Negative output voltage, internal short to Pin 3
5	Vsense-	Negative remote sense. See note 1 (S option)
	Iset	Output current trim (C option)
6	Vset	Output voltage trim
7	Vsense+	Positive remote sense. See note 2 (S option)
	Imon	Scaled representation of output current (C option)
8	+Vout	Positive output voltage

Notes:

- 1) Vsense- should be connected to -VOUT either remotely or at the converter
- 2) Vsense+ should be connected to +VOUT either remotely or at the converter

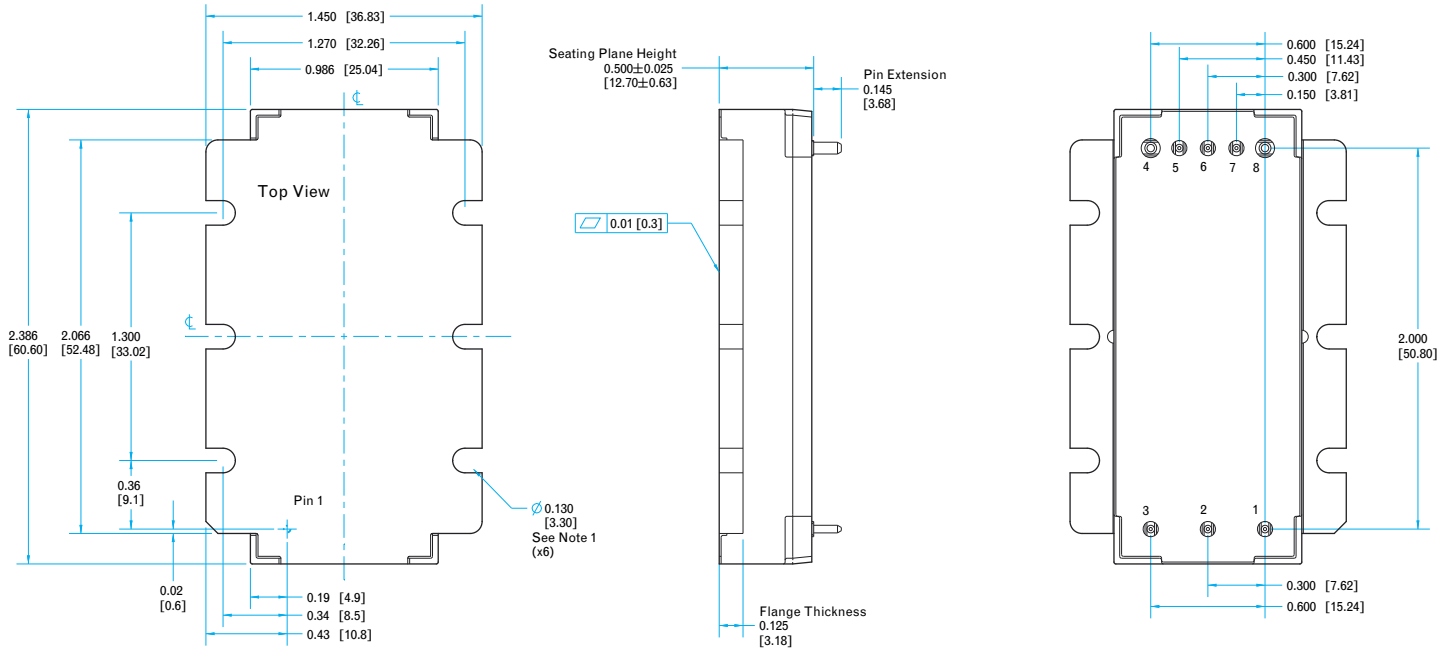

NOTES

- 1) APPLIED TORQUE PER SCREW SHOULD NOT EXCEED 6in-lb.
- 2) BASEPLATE FLATNESS TOLERANCE IS 0.004" (.10mm) TIR FOR SURFACE
- 3) PINS 1-3, 5-7 ARE 0.040" (1.02mm) DIA. WITH 0.080" (2.03mm) DIA. STANDOFF SHOULDERS
- 4) PINS 4 AND 8 ARE 0.062" (1.57mm) DIA. WITH 0.100" (2.54mm) DIA. STANDOFF SHOULDERS
- 5) ALL PINS: MATERIAL: COPPER ALLOY
FINISH: MATTE TIN OVER NICKEL PLATE
- 6) UNDIMENSIONED COMPONENTS ARE SHOWN FOR VISUAL REFERENCE ONLY
- 7) ALL DIMENSIONS IN INCHES(mm)
TOLERANCES: X.XXIN +/-0.02 (X.Xmm +/-0.5mm)
X.XXXIN +/-0.010 (X.XXmm +/-0.25mm)
- 8) WEIGHT: 2.3 oz (66g) TYPICAL
- 9) WORKMANSHIP: MEETS OR EXCEEDS IPC-A-610 CLASS II

PIN DESIGNATIONS

Pin	Label	Function
1	+VIN	Positive input
2	ON/OFF	TTL input to turn converter on and off, referenced to Vin(-), with internal pull up
3	-VIN	Negative input voltage, internal short to Pin 4
4	-Vout	Negative output voltage, internal short to Pin 3
5	Vsense-	Negative remote sense. See note 1 (S option)
	Iset	Output current trim (C option)
6	Vset	Output voltage trim
7	Vsense+	Positive remote sense. See note 2 (S option)
	Imon	Scaled representation of output current (C option)
8	+Vout	Positive output voltage

Notes:

- 1) Vsense- should be connected to -VOUT either remotely or at the converter
- 2) Vsense+ should be connected to +VOUT either remotely or at the converter

NQ40W40EPx20 Electrical Characteristics

Ta = 25 °C, airflow rate = 300 LFM, Vin = 28 V dc unless otherwise noted; full operating temperature range is -40 °C to +100 °C baseplate temperature with appropriate power derating. Specifications subject to change without notice.

Parameter	Vout	Min.	Typ.	Max.	Units	Notes & Conditions
ABSOLUTE MAXIMUM RATINGS						
Input Voltage						
Non-Operating	All	-1		60	V	Continuous
Operating	All			40	V	Continuous
Isolation Voltage						
Input to Baseplate				1150	Vdc	
Output to Baseplate				1150	Vdc	
Storage Temperature	All	-45		125	°C	
Voltage at ON/OFF input pin	All	0		5.5	V	
Voltage at Vset and Iset Pins		-0.2		3.5	V	Note 1
Voltage between Vsense+ and +Vout pins				±6.0	V	
Voltage between Vsense- and -Vout pins				±0.25	V	
RECOMMENDED OPERATING CONDITIONS						
Input Voltage Range	All	9		40	V	Turn on at 10V
Input Fuse Rating	All			30	A	Fast blow external fuse recommended
Input Current				20	A	Input current max equals output rated current
External Input Capacitance	All	1000			µF	ESR > 50 mΩ See Note 2
Output Voltage	All	0		40	V	
Output Current	All	0		20	A	Input voltage dependent
INPUT CHARACTERISTICS						
Input Under-Voltage Lockout						
Turn-On Voltage Threshold	All	9.2	9.5	10	V	
Turn-Off Voltage Threshold	All	5.1	5.6	6.1	V	
Lockout Hysteresis	All		4.0		V	
Input Current Limit	All			23.0	A	
No-Load Input Current	12		135		mA	
"	28		65		mA	
"	40		200		mA	
Disabled Input Current	All		0.8		mA	
Input Filter Components Value (L\C)	All		0.68\100		µH\µF	
OUTPUT CHARACTERISTICS						
Output Voltage Range	All	0		40	V	Set by Vset resistor
Operating Output Current Range	All	0		20	A	
Output Voltage Regulation						
Load Regulation	All		-2%*Vout*Iout/Imax			
Total Output Voltage Range	All		±100mV ±2%*Vout + Load Reg			Between Sense pins, over sample, line, load, temp. & life.
Output Voltage Ripple and Noise (pk-pk/28Vin)	12		100		mV	28 Vin Full Load; 100uF; 20 MHz b.w.
"	28		200		mV	"
"	40		200		mV	"
Output DC Over Current limit	All		23.0		A	Effective on input, output condition
External Output Capacitance	All	100			µF	ESR > 1 mΩ
Output Filter Components (C\L)	All		110\0.68		µF\µH	
Reverse Current	All		1		µA	Disabled

NQ40W40EPx20 Electrical Characteristics (continued)

Ta = 25 °C, airflow rate = 300 LFM, Vin = 28 V dc unless otherwise noted; full operating temperature range is -40 °C to +100 °C baseplate temperature with appropriate power derating. Specifications subject to change without notice.

Parameter	Vout	Min.	Typ.	Max.	Units	Notes & Conditions
DYNAMIC CHARACTERISTICS						
Output Voltage during Current Transient						
For a Step Change in Output Current	12		350		mV	(0.1 A/μs); 50%-75%-50% Iout max
Settling Time	12		300		us	To within 1.5% Vout nom.
For a Step Change in Output Current	28		600		mV	(0.1 A/μs); 50%-75%-50% Iout max
Settling Time	28		700		us	To within 1.5% Vout nom.
Turn on Transient						
Startup delay	All		2		ms	Resistive load
Rise Rate	All		1.2		V/ms	"
Output Voltage Overshoot	All		0		V	"
EFFICIENCY						
100% Load; 24 Vin	12		94		%	
100% Load; 36 Vin	24		96		%	
100% Load; 12 Vin	36		93		%	
50% Load; 24 Vin	12		95		%	
50% Load; 36 Vin	24		96		%	
50% Load; 12 Vin	36		93		%	
FEATURE CHARACTERISTICS						
Switching Frequency	All	240	250	260	KHz	
On/Off, Negative (N) Logic						
Off-State Threshold Voltage	All		1.4	1.5	V	See REMOTE ON/OFF: in CONTROL FEATURES
On-State Threshold Voltage	All	1.0	1.1		V	
Threshold Hysteresis	All		0.3		V	
Pin Pull-Up Voltage	All		5.0		V	
Pin Pull-Up Resistance	All		25		kΩ	
Output Voltage Setpoint						
Pin Pull-Up Voltage	All		2.5		V	See OUTPUT VOLTAGE SETPOINT: in CONTROL FEATURES
Pin Pull-Up Resistance	All		10.9		kΩ	
Output Voltage Setpoint Range	All	0		40	V	
Output Over-Voltage Shutdown	All		47		V	Fixed - Does not vary with output setpoint
Output Current Setpoint (C-option only)						
Pin Pull-Up Voltage	All		2.5		V	See OUTPUT CURRENT SETPOINT: in CONTROL FEATURES
Pin Pull-Up Resistance	All		10		kΩ	
Output Current Setpoint Range	All	0		20	A	
Input/Output Current Limit	All	21	23	25	A	
I _{mon}						
Pin Voltage at No Load	All		0.2		V	
Pin Voltage at Full Load (I _{max})	All		2.2		V	
Pin Output Resistance	All		2.5		kΩ	
Over-Temperature Shutdown	All		115		°C	Average PCB Temperature
Over-Temperature Shutdown Restart Hysteresis	All		15		°C	
RELIABILITY CHARACTERISTICS						
Calculated MTBF (TR-NWT-000332; Telcordia)	All		3.6		10 ⁶ Hrs.	70 °C Tbaseplate
Calculated MTBF (MIL-HDBK-217F; MIL-217)	All		3.2		10 ⁶ Hrs.	70 °C Tbaseplate
Field Demonstrated MTBF	All				10 ⁶ Hrs.	See our website for details
TEMP LIMITS FOR POWER DERATING						
Semiconductor Junction Temperature	All			125	°C	Package rated to 150 °C
Board Temperature	All			125	°C	UL rated max operating temp 130 °C
Baseplate Temperature	All			100	°C	

Note 1: All control signals are referenced to Vsense- pin.

Note 2: Input capacitance and ESR of input capacitance dictated by input stability requirements. For Vin << 28V and/or Vout >> 28V consult SynQor Field Applications. Please see SynQor Application Note:

http://www.synqor.com/documents/appnotes/appnt_System_Instability.pdf

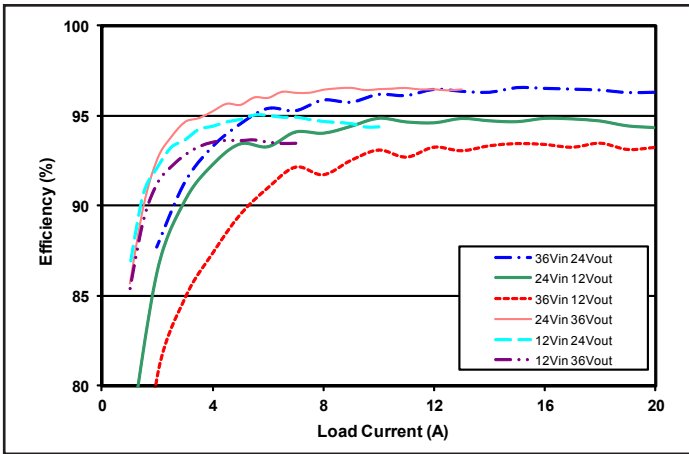

Figure 1: Efficiency at different output voltages vs. load current for different input voltages at 25°C.

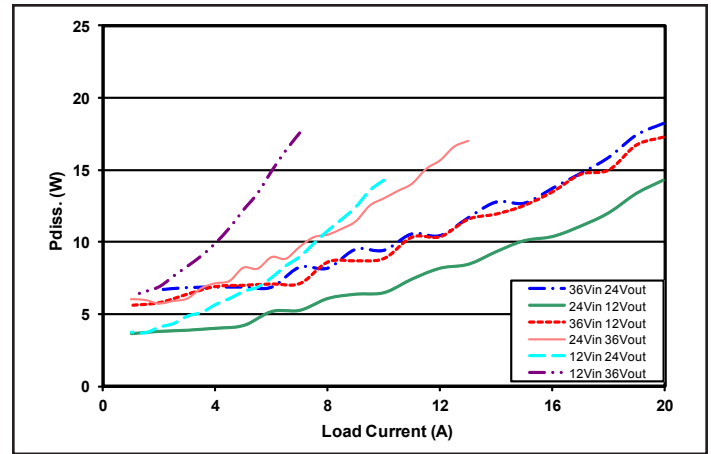

Figure 2: Power dissipation at different output voltages vs. load current for different input voltages at 25°C.

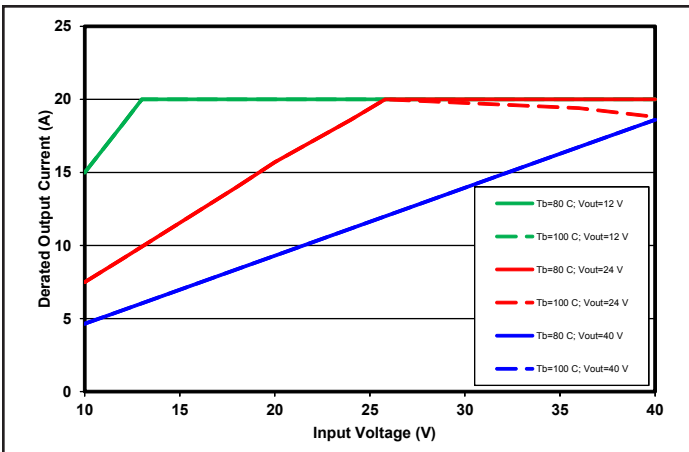

Figure 3: Maximum output power derating curve with a controlled baseplate temperature of 80°C and 100°C vs. Input voltage.

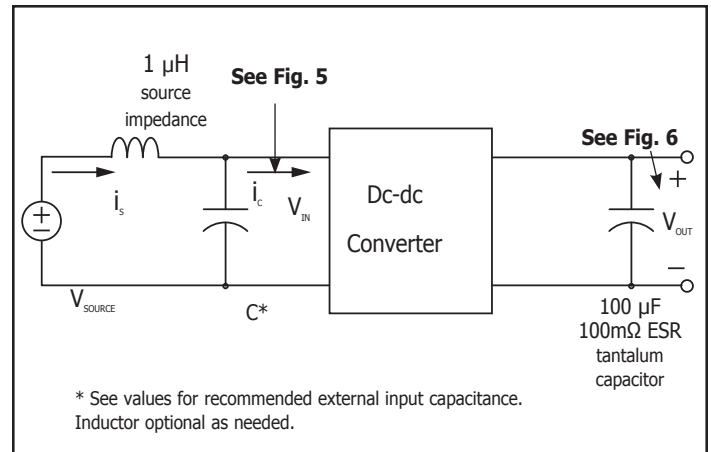

Figure 4: Test set-up diagram showing measurement points for Input Terminal Ripple Current (Fig 5) and Output Voltage Ripple (Fig 6).

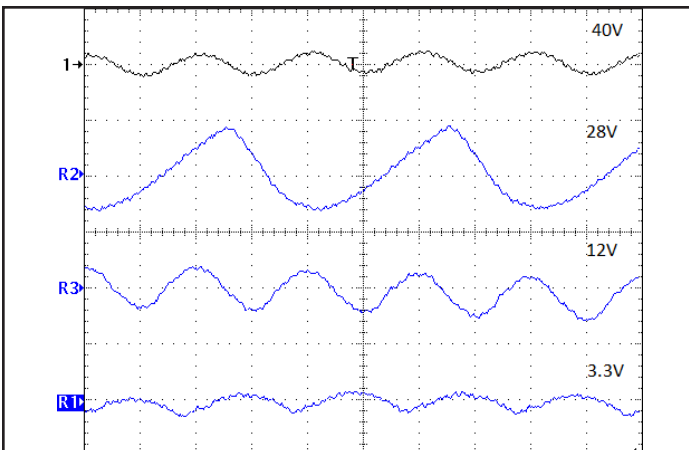

Figure 5: Input Terminal Ripple Current at 28V input and rated load current (500mA/div). Load capacitance: 100µF electrolytic cap. Bandwidth: 20MHz, (2uS/div). See Figure 4

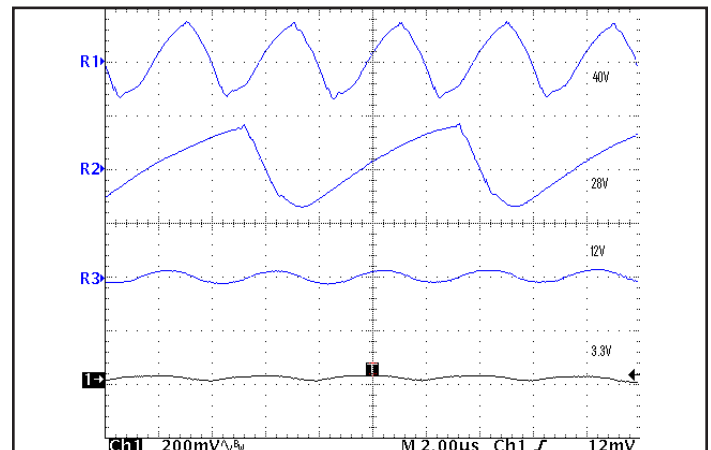

Figure 6: Output Voltage Ripple at 28V input and rated load current (200mV/div). Load capacitance: 100µF electrolytic cap. Bandwidth: 20MHz, (2uS/div). See Figure 4.

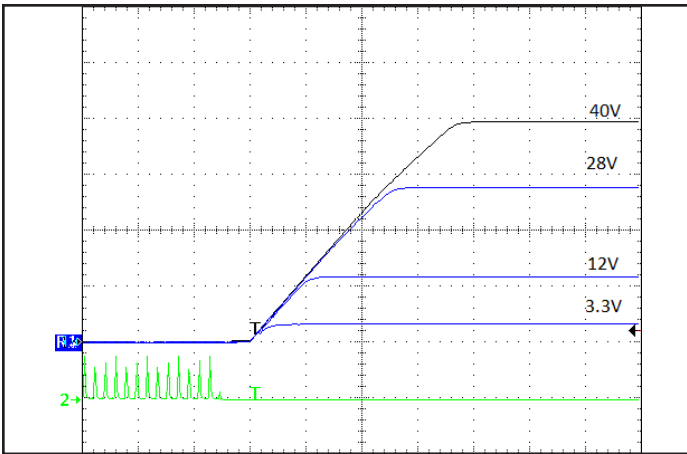

Figure 7: Turn-on transient at 28V input; full load (10ms/div). Top Traces: Vout (10V/div). Bottom Trace: ON/OFF input (5V/div)

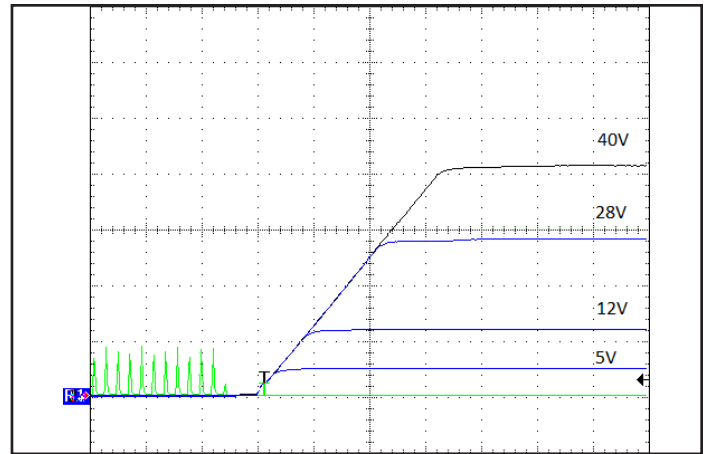

Figure 8: Turn-on transient at 28V input; zero load (10ms/div). Top Traces: Vout (10V/div). Bottom Trace: ON/OFF input (5V/div)

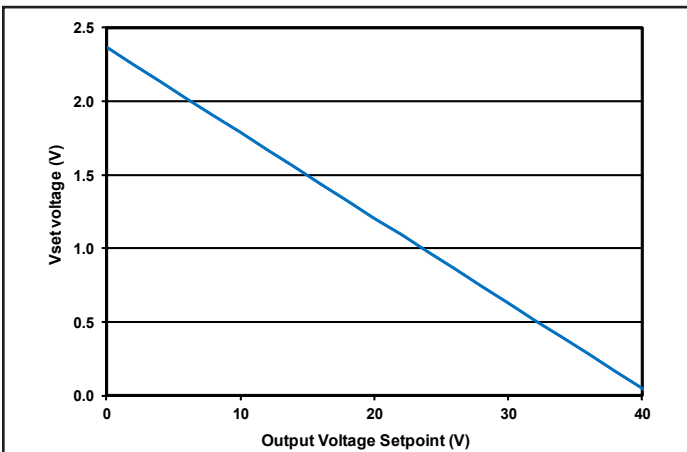

Figure 9: Vset pin voltage vs. Output Voltage Setpoint.

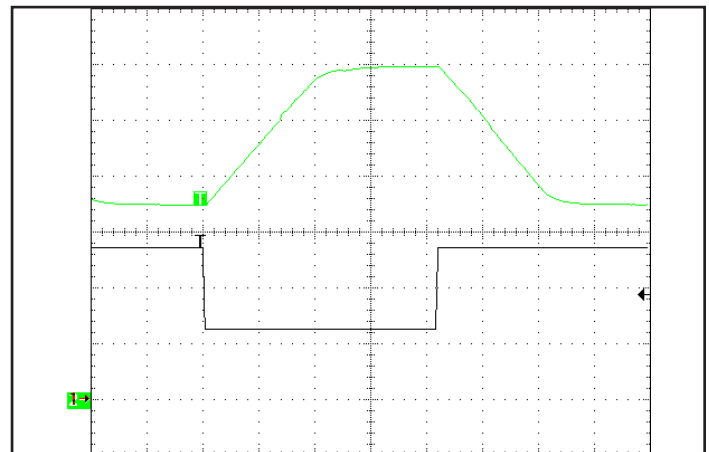

Figure 10: Output Voltage vs. Vset pin voltage dynamics; 28Vin, 2A out (5ms/div). Top trace: Vset pin voltage (500mV/div). Bottom trace: Output Voltage (5V/div).

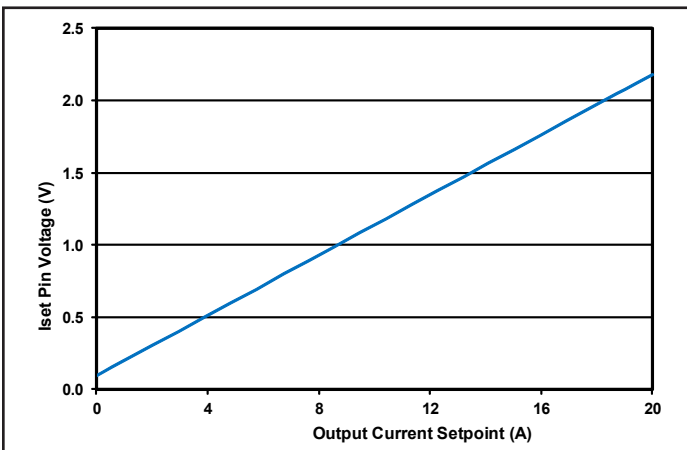

Figure 11: Iset pin voltage vs. Output Current Limit Setpoint.

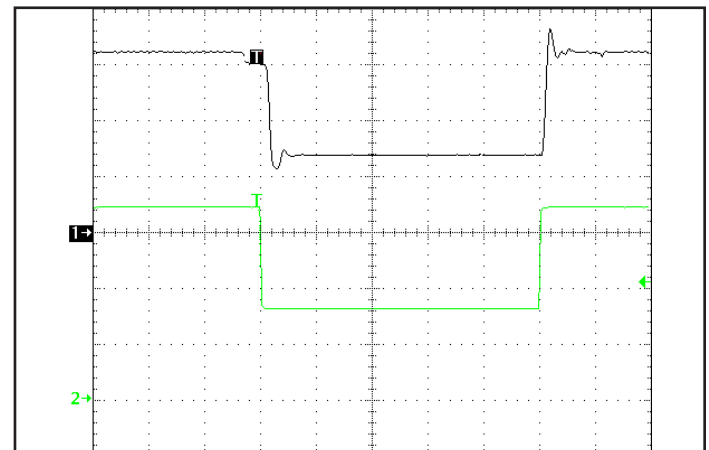

Figure 12: Output Current vs Iset pin voltage dynamics; 28Vin 5Vout (5ms/div). Top Trace: Output Current (5A/div). Bottom Trace: Iset pin voltage (500mV/div).

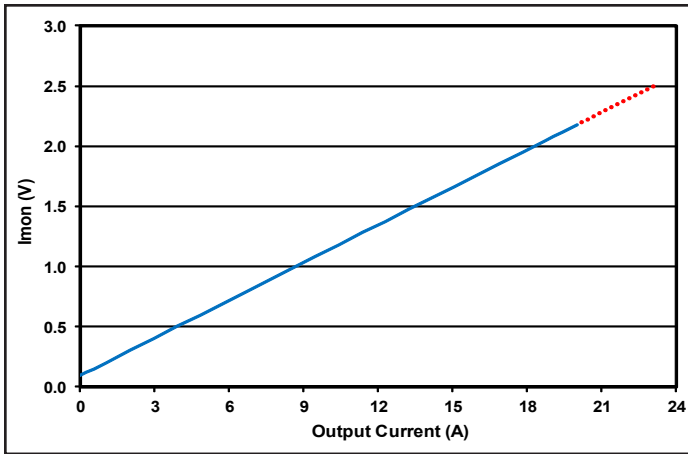

Figure 13: Imon pin Voltage vs. Output Load Current.



Figure 14: Output voltage response for 28V input; 3.3V, 12V, 28V, 40V output to step change in load current (50%-75%-50% of Iout max; di/dt=0.1A/uS). Load cap: 100uF electrolytic cap, Vout (500mV/div); (5mS/div)

Standards & Qualifications

Parameter	Notes & Conditions
STANDARDS COMPLIANCE	
UL 60950-1	
EN 60950-1	
CAN/CSA C22.2 No. 60950-1	

Note: An external input fuse must always be used to meet these safety requirements.

Contact SynQor for official safety certificates on new releases or download from the SynQor website.

Parameter	# Units	Test Conditions
QUALIFICATION TESTING		
Life Test	32	95% rated Vin and load, units at derating point, 1000 hours
Vibration	5	10-55 Hz sweep, 0.060" total excursion, 1 min./sweep, 120 sweeps for 3 axis
Mechanical Shock	5	100g minimum, 2 drops in x, y and z axis
Temperature Cycling	10	-40 °C to 100 °C, unit temp. ramp 15 °C/min., 500 cycles
Power/Thermal Cycling	5	Toperating = min to max, Vin = min to max, full load, 100 cycles
Design Marginality	5	Tmin-10 °C to Tmax+10 °C, 5 °C steps, Vin = min to max, 0-105% load
Humidity	5	85 °C, 95% RH, 1000 hours, continuous Vin applied except 5 min/day
Solderability	15 pins	MIL-STD-883, method 2003
Altitude	2	70,000 feet (21 km), see Note

Note: A conductive cooling design is generally needed for high altitude applications because of naturally poor convective cooling at rare atmospheres.

BASIC OPERATION AND FEATURES

This converter consists of integrated buck and boost converters, both controlled simultaneously by a digital controller. It automatically changes operating mode (buck mode or boost) when the line voltage or output set point changes. Very high efficiency is maintained over wide input and output ranges by shifting operational modes and use of synchronous rectifiers.

The converter runs at a fixed frequency with a predictable EMI performance.

This Eighth-brick converter uses the industry standard footprint and pin-out configuration. A typical V-I characteristic, with Vsetpoint=30V and Isetpoint=15A, when operating from Vin=20V, is shown in Figure A.

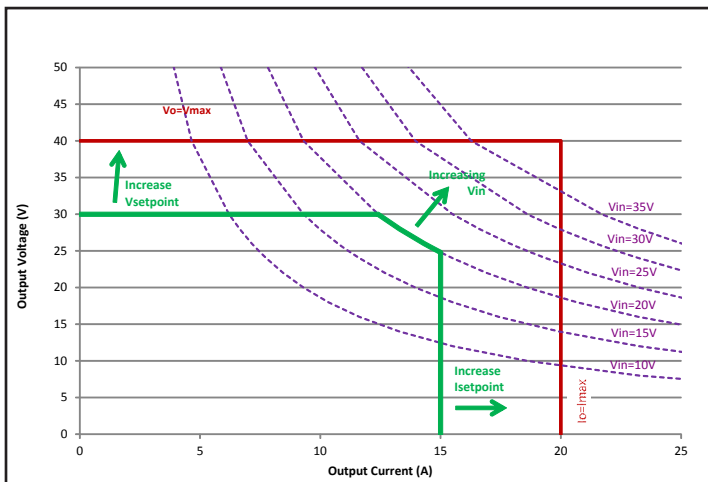

Figure A: V-I Characteristics of HVNQ.

CONTROL FEATURES

REMOTE ON/OFF: Only Negative On/Off logic is available in the converter series: logic high at the input turns the converter Off while a logic low turns in On. Timing of this is shown in Figures 7, 8. A high level can be driven to any voltage between 1.5V and 3.3V, or simply left floating as the unit contains an internal 25KΩ pull-up to 5.0V. The pin can be pulled low (to Vsense-) by an optocoupler, an open-source/drain transistor or wired permanently to Vsense-. To provide noise immunity the input has 0.3V of hysteresis.

Multiple units that have a common Vsense- connection can be controlled by the same On/Off signal, but it is recommended that a small schottky diode be added to each input as shown in Figure B.

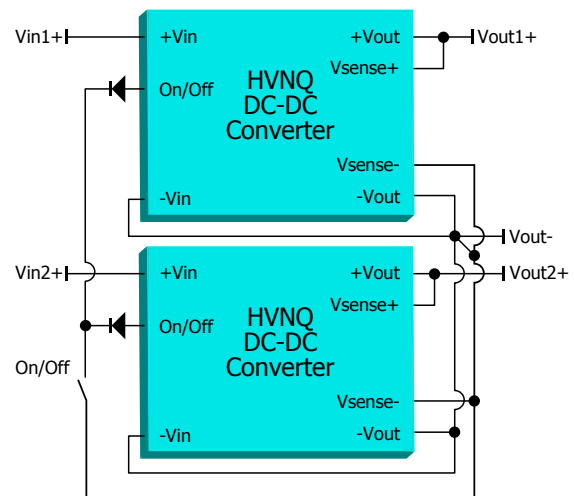

Figure B: Schematic for ON/OFF connection with multiple units.

OUTPUT VOLTAGE SETPOINT: The output voltage can be programmed to any voltage between 0 V dc and Vmax by connecting one resistor between the Pin 6 (Vset) and Pin 5 [Vsense(-)](S-Version) or Pin 4 [-Vout](C-version); See Figure C. For a desired output voltage, the value of the resistor should be:

$$R_{vset}(Vset) = \left[\left(\frac{11830 \times V_{max}}{Vset + 0.058 \times V_{max}} \right) - 10912 \right] (\Omega)$$

NOTE: To maintain the accuracy of the output voltage over load current, it is vital that the trim resistor be connected to the converter's Vsense(-) pin (for the S-option) or -Vout pin (for the C-option), locally at the converter, not at a remote location nearer to the load. A separate Kelvin connection to the PCB pad for the -Vout is optimal for the C-option.

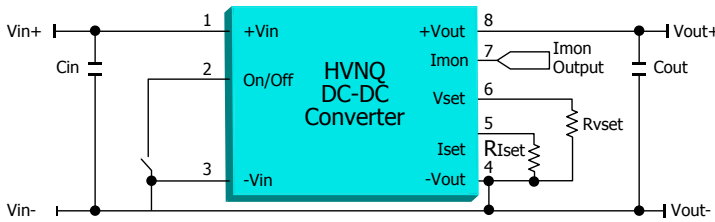

Figure C: Schematic for Vset and Iset connections.

Alternatively, the Vset pin can be driven from an external voltage source: Undriven, this pin floats at 2.5V which sets the output to 0V. See Figure 10 for the large scale dynamics of this input.

$$V_{vset}(V_{set}) = 2.366 - 2.316 \left(\frac{V_{set}}{V_{max}} \right) \text{ V}$$

See Figure 9

where:

Vset = desired output voltage setpoint

Vmax = maximum rated output voltage (40V)

OUTPUT CURRENT SETPOINT: The maximum output current (effectively the current limit) can be reduced to any value between 0 and Imax by connecting one resistor between the Iset pin (5) and Vout- (4); see Figure C. The value of the resistor should be:

$$R_{Iset}(I_{set}) = \left[\left(\frac{0.0469 I_{max} + I_{set}}{1.153 I_{max} - I_{set}} \right) * 10200 - 10 \right] (\Omega)$$

Alternatively, the Iset pin can be driven from an external voltage source:

$$V_{iset}(I_{set}) = \left(0.0953 + 2.085 * I_{set}/I_{max} \right) \text{ V}$$

where:

Iset = desired output current setpoint

Imax = maximum rated output current (20A)

Undriven, the Iset pin floats to 2.5V which sets the current limit at its nominal value of 115%*Imax. See Figure 12 for the large signal dynamics of this control.

PROTECTION FEATURES

Input Under-Voltage Lockout: The converter is designed to turn off when the input voltage is too low, helping avoid an input system instability problem, described in more detail in the application note titled "Input System Instability". The lockout circuitry is a comparator with DC hysteresis. When the input voltage is rising, it must exceed the typical Turn-On Voltage Threshold value (listed on the specification page) before the converter will turn on. Once the converter is on, the input voltage must fall below the typical Turn-Off Voltage Threshold value before the converter will turn off.

Output Current Shutdown: To provide protection in an output short condition, the unit is equipped with internal short circuit protection. When the short-circuit protection is triggered, the converter shuts down and then waits an inhibit time (~100ms), after which it tries to turn on again. If the short condition remains, the current limit circuit will limit the output current. The unit will return to normal operation once the fault condition is removed.

Internal Over-Voltage Protection: To fully protect from excessive output voltage, the unit contains an output over-voltage shutdown that is fixed at ~110% of Vmax. If this limit is reached, the converter shuts down and then waits an inhibit time (~100ms), after which it restarts.

Over-Temperature Shutdown: Two sensors in the module monitor the temperature of both the buck and boost sections. When the temperature at either sensor exceeds the Over Temperature Shutdown value, the converter is disabled. It will restart normally when it then cools by the amount of the Over-Temperature Shutdown Hysteresis.

APPLICATION CONSIDERATIONS

Input filtering: These modules should be connected to a low-impedance source. A highly inductive source can affect the stability of the module. An input capacitor must be placed adjacent to the input pins of the module to minimize input ripple voltage and ensure stability. See SynQor's application note titled Input System Stability for guidance on selecting appropriate input filter elements.

http://www.synqor.com/documents/appnotes/appnt_System_Instability.pdf

Output capacitance: An output capacitor of at least 100uF with an ESR of ~50mOhms is recommended to damp the resonance of the output filter. More capacitance can be added to improve dynamic response to load variation; there is no upper limit on the value of the output capacitance. Very large output capacitors may slow the converter's start up time due to the current required to charge them being limited by current limit or Isetpoint.

Remote sense (S-option only): In the event of an open sense line, the module maintains output voltage regulation via internal resistors between its Vsense+ and +Vout, and Vsense- and -Vout pins. To avoid damaging those resistors, maintain the voltage differentials to within the limits in ABSOLUTE MAXIMUM RATINGS at all times.

Current limit: Available current is limited by output current setpoint (at Iset) or input current limit (at Imax, whichever comes first. If Iset is maximized (Iset = Imax) then,

for $V_{in} > V_{out}$

$$I_{limit} = 1.12 \times I_{max} \text{ (Amps)}$$

for $V_{in} < V_{out}$

where I_{max} = Maximum rated output current

$$I_{limit} = 1.12 \times I_{max} \left(\frac{V_{in}}{V_{out}} \right) \text{ (Amps)}$$

Generating Negative output voltage (inversion): The circuit shown in Figure D can be used to generate a negative output voltage from a positive input.

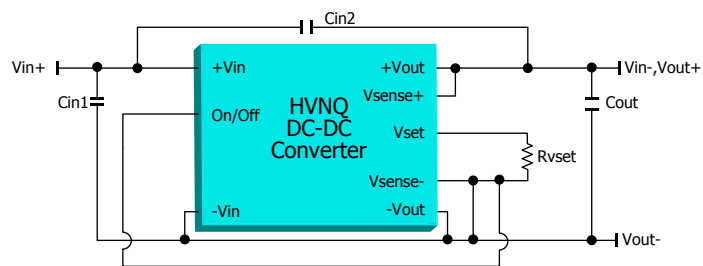

Figure D: Negative output setup

Note that all control signals are referenced to Vsense-, which in this arrangement is at -Vout potential.



Ordering Information

Input: 9-40V
Outputs: 0-40V
Current: 20A
Package: Eighth-brick

PART NUMBERING SYSTEM

The part numbering system for SynQor's dc-dc converters follows the format shown in the example below.

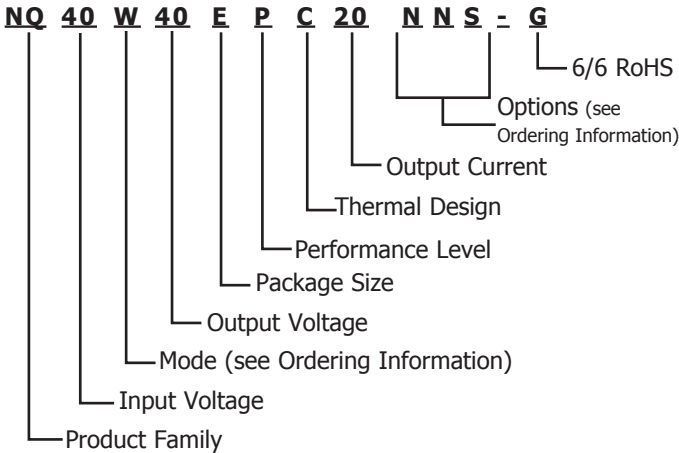

The first 12 characters comprise the base part number and the last 3 characters indicate available options. The "-G" suffix indicates 6/6 RoHS compliance.

Application Notes

A variety of application notes and technical white papers can be downloaded in pdf format from our website.

RoHS Compliance: The EU led RoHS (Restriction of Hazardous Substances) Directive bans the use of Lead, Cadmium, Hexavalent Chromium, Mercury, Polybrominated Biphenyls (PBB), and Polybrominated Diphenyl Ether (PBDE) in Electrical and Electronic Equipment. This SynQor product is 6/6 RoHS compliant. For more information please refer to SynQor's RoHS addendum available at our [RoHS Compliance / Lead Free Initiative web page](#) or e-mail us at rohs@synqor.com.

Contact SynQor for further information and to order:
Phone: 978-849-0600 **Toll Free:** 888-567-9596 **Fax:** 978-849-0602
E-mail: power@synqor.com **Web:** www.synqor.com
Address: 155 Swanson Road, Boxborough, MA 01719 USA

WARRANTY
 SynQor offers a two (2) year limited warranty. Complete warranty information is listed on our website or is available upon request from SynQor.

ORDERING INFORMATION

The tables below show the valid model numbers and ordering options for converters in this product family. When ordering SynQor converters, please ensure that you use the complete 15 character part number consisting of the 12 character base part number and the additional 3 characters for options. Add "-G" to the model number for 6/6 RoHS compliance.

Model Number	Input Voltage	Output Voltage	Max Output Current
NQ40w40EPx20Nyz-G	9-40V	0-40V	20A

The following options must be included in place of the **wxyz** spaces in the model numbers listed above.

Options Description: x y z				
Mode: w	Thermal Design: x	Enable Logic	Pin Style: y	Feature Set: z
W - Buck / Boost	C - Encased V - Encased with Flanged Baseplate	N - Negative	N - 0.145" R - 0.180" Y - 0.250"	S - Standard C - Current monitor output / Trimmable current limit

Not all combinations make valid part numbers, please contact SynQor for availability. See the [Product Summary web page](#) for more options.

PATENTS
 SynQor holds numerous U.S. patents, one or more of which apply to most of its power conversion products. Any that apply to the product(s) listed in this document are identified by markings on the product(s) or on internal components of the product(s) in accordance with U.S. patent laws. SynQor's patents include the following:
 6,896,526 6,927,987 7,050,309 7,765,687
 7,787,261 8,149,597 8,644,027